

Multi-Range DC Power Supply

PSW Series

PROGRAMMING MANUAL

GW INSTEK PART NO. 825W-80400E01



ISO-9001 CERTIFIED MANUFACTURER

GW INSTEK

This manual contains proprietary information, which is protected by copyright. All rights are reserved. No part of this manual may be photocopied, reproduced or translated to another language without prior written consent of Good Will company.

The information in this manual was correct at the time of printing. However, Good Will continues to improve products and reserves the rights to change specification, equipment, and maintenance procedures at any time without notice.

Good Will Instrument Co., Ltd.
No. 7-1, Jhongsing Rd., Tucheng Dist., New Taipei City 236, Taiwan.

Table of Contents

SAFETY INSTRUCTIONS	4
GETTING STARTED.....	8
PSW Series Overview	9
Appearance.....	11
Configuration Settings	17
REMOTE CONTROL	21
Interface Configuration	22
Command Syntax	26
Command List	29
Status Register Overview	63
Error List	75
APPENDIX	84
PSW Default Settings	84
Error Messages & Messages	86
LCD Display Format.....	86
INDEX.....	87

S SAFETY INSTRUCTIONS

This chapter contains important safety instructions that you must follow during operation and storage. Read the following before any operation to insure your safety and to keep the instrument in the best possible condition.

Safety Symbols

These safety symbols may appear in this manual or on the instrument.



Warning: Identifies conditions or practices that could result in injury or loss of life.



Caution: Identifies conditions or practices that could result in damage to the PSW or to other properties.



DANGER High Voltage



Attention Refer to the Manual



Protective Conductor Terminal



Earth (ground) Terminal



Do not dispose electronic equipment as unsorted municipal waste. Please use a separate collection facility or contact the supplier from which this instrument was purchased.

Safety Guidelines

General Guideline



CAUTION

- Do not place any heavy object on the PSW.
- Avoid severe impact or rough handling that leads to damaging the PSW.
- Do not discharge static electricity to the PSW.
- Use only mating connectors, not bare wires, for the terminals.
- Do not block the cooling fan opening.
- Do not disassemble the PSW unless you are qualified.

(Measurement categories) EN 61010-1:2001 specifies the measurement categories and their requirements as follows. the PSW falls under category II.

- Measurement category IV is for measurement performed at the source of low-voltage installation.
- Measurement category III is for measurement performed in the building installation.
- Measurement category II is for measurement performed on the circuits directly connected to the low voltage installation.
- Measurement category I is for measurements performed on circuits not directly connected to Mains.

Power Supply



WARNING

- AC Input voltage range: 85VAC~265VAC
 - Frequency: 47Hz~63Hz
 - To avoid electrical shock connect the protective grounding conductor of the AC power cord to an earth ground.
-

-
- Cleaning the PSW
- Disconnect the power cord before cleaning.
 - Use a soft cloth dampened in a solution of mild detergent and water. Do not spray any liquid.
 - Do not use chemicals containing harsh material such as benzene, toluene, xylene, and acetone.
-

Operation
Environment

- Location: Indoor, no direct sunlight, dust free, almost non-conductive pollution (Note below)
- Relative Humidity: 20%~ 85%
- Altitude: < 2000m
- Temperature: 0°C to 50°C

(Pollution Degree) EN 61010-1:2001 specifies the pollution degrees and their requirements as follows. The PSW falls under degree 2.

Pollution refers to “addition of foreign matter, solid, liquid, or gaseous (ionized gases), that may produce a reduction of dielectric strength or surface resistivity”.

- Pollution degree 1: No pollution or only dry, non-conductive pollution occurs. The pollution has no influence.
 - Pollution degree 2: Normally only non-conductive pollution occurs. Occasionally, however, a temporary conductivity caused by condensation must be expected.
 - Pollution degree 3: Conductive pollution occurs, or dry, non-conductive pollution occurs which becomes conductive due to condensation which is expected. In such conditions, equipment is normally protected against exposure to direct sunlight, precipitation, and full wind pressure, but neither temperature nor humidity is controlled.
-

Storage
environment

- Location: Indoor
 - Temperature: -25°C to 70°C
 - Relative Humidity: <90%
-

Disposal



Do not dispose this instrument as unsorted municipal waste. Please use a separate collection facility or contact the supplier from which this instrument was purchased. Please make sure discarded electrical waste is properly recycled to reduce environmental impact.

Power cord for the United Kingdom

When using the power supply in the United Kingdom, make sure the power cord meets the following safety instructions.

NOTE: This lead/appliance must only be wired by competent persons



WARNING: THIS APPLIANCE MUST BE EARTHED

IMPORTANT: The wires in this lead are coloured in accordance with the following code:

Green/ Yellow:	Earth
Blue:	Neutral
Brown:	Live (Phase)



As the colours of the wires in main leads may not correspond with the coloured marking identified in your plug/appliance, proceed as follows:

The wire which is coloured Green & Yellow must be connected to the Earth terminal marked with either the letter E, the earth symbol  or coloured Green/Green & Yellow.

The wire which is coloured Blue must be connected to the terminal which is marked with the letter N or coloured Blue or Black.

The wire which is coloured Brown must be connected to the terminal marked with the letter L or P or coloured Brown or Red.

If in doubt, consult the instructions provided with the equipment or contact the supplier.

This cable/appliance should be protected by a suitably rated and approved HBC mains fuse: refer to the rating information on the equipment and/or user instructions for details. As a guide, a cable of 0.75mm² should be protected by a 3A or 5A fuse. Larger conductors would normally require 13A types, depending on the connection method used.

Any exposed wiring from a cable, plug or connection that is engaged in a live socket is extremely hazardous. If a cable or plug is deemed hazardous, turn off the mains power and remove the cable, any fuses and fuse assemblies. All hazardous wiring must be immediately destroyed and replaced in accordance to the above standard.

GETTING STARTED

This chapter describes the power supply in a nutshell, including its main features and front / rear panel introduction. After going through the overview, please read the theory of operation to become familiar with the operating modes, protection modes and other safety considerations.



PSW Series Overview	9
Series lineup.....	9
Main Features.....	10
Appearance	11
PSW Front Panel.....	11
Rear Panel.....	14
Configuration Settings	17
Setting Configuration Settings.....	17

PSW Series Overview

Series lineup

The PSW series consists of 6 models, divided into 3 different model types covering 3 power capacities: Type I (360 Watt), Type II (720 Watt) and Type III (1080 Watt).

Model name	Type	Voltage Rating	Current Rating	Power
PSW 30-36	Type I	0~30V	0~36A	360W
PSW 80-13.5	Type I	0~80V	0~13.5A	360W
PSW 30-72	Type II	0~30V	0~72A	720W
PSW 80-27	Type II	0~80V	0~27A	720W
PSW 30-108	Type III	0~30V	0~108A	1080W
PSW 80-40.5	Type III	0~80V	0~40.5A	1080W

Apart from the differences in output, each unit differs in size. The 720 and 1080 watt models are larger than the 360 watt models to accommodate the increase in power.

360 Watt models

720 Watt models

1080 Watt models

Type I

Type II

Type III

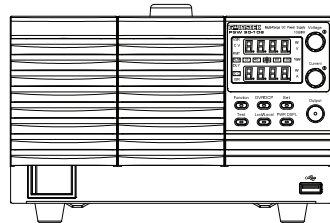
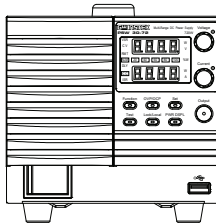
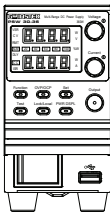

Main Features

- | | |
|-------------|----------------------------------------------------------------------------------------------------------------------------------------------------------------------------------------------------------------------------------------------------------------------------------------------------------------------------------------------------------------------------------------------------------------------------------------------------------------------------------------|
| Performance | <ul style="list-style-type: none">• High performance/power• Power efficient switching type power supply• Low impact on load devices• Fast transient recovery time of 1ms• Fast output response time |
| Features | <ul style="list-style-type: none">• OVP, OCP and OTP protection• Adjustable voltage and current slew rates• User adjustable bleeder control to quickly dissipate the power after shutdown to safe levels.• Extensive remote monitoring and control options• Support for serial and parallel connections• Power on state configuration settings.• Supports test scripts• Web server monitoring and control |
| Interface | <ul style="list-style-type: none">• Ethernet port• Analog connector for analog voltage and current monitoring• USB host and device port |

Appearance

PSW Front Panel

PSW 80-27, PSW 30-72 (720W)

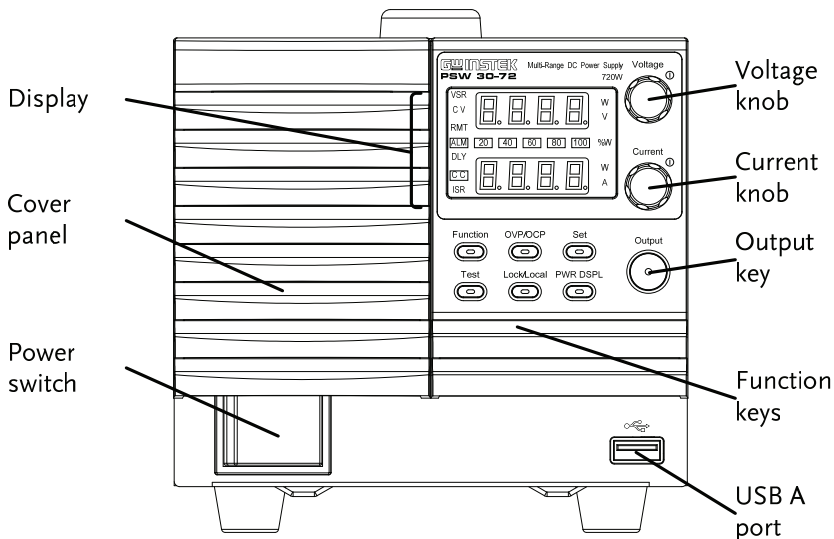

PSW 80-40.5, PSW 30-108 (1080W)

PSW 80-13.5,
PSW 30-36 (360W)

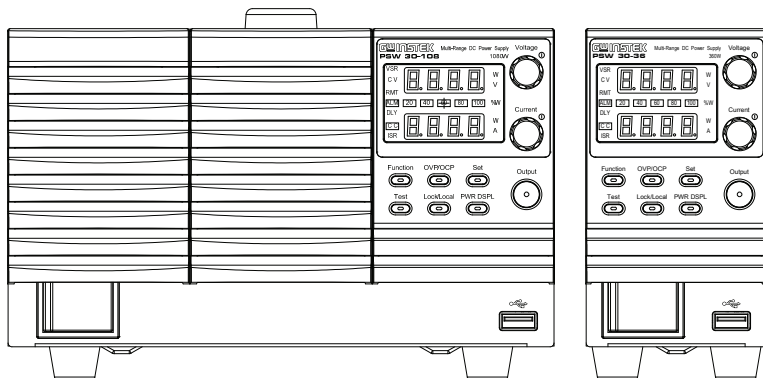

Function Keys The Function keys along with the Output key will light up when a key is active.

- Function



The Function key is used to configure the power supply.
- OVP/OCP



Set the over current or over voltage protection levels.
- Set



Sets the current and voltage limits.
- Test



Used to run customized scripts for testing. Please contact GW Instek for more details.
- Lock/Local



Locks or unlocks the panel keys to prevent accidentally changing panel settings. When in remote control mode, pressing the Lock/Local key will return the instrument to local control mode.
- PWR DSPL



Toggles the display from viewing V/A→V/W→A/W.

- Display Indicators**
- VSR** Voltage Slew Rate
 - C V** Constant Voltage Mode
 - RMT** Remote Control Mode
 - ALM** Alarm on
 - DLY** Delay Output
 - CC** Constant Current Mode

ISR
20 **40** **60**
80 **100** % W

Current Slew Rate
 Power bar
 Indicates the current power output as a percentage.

Voltage Knob

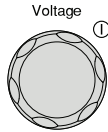

Sets the voltage.

Current Knob

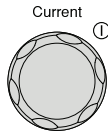

Sets the current.

Output

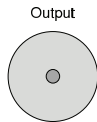

Press to turn on the output. The Output key will light up when the output is active.

USB

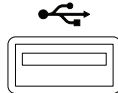

USB A port for data transfer, loading test scripts etc.

Power Switch

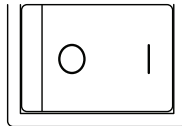

Used to turn the power on/off.

Rear Panel

PSW 80-27, PSW 30-72 (720W)

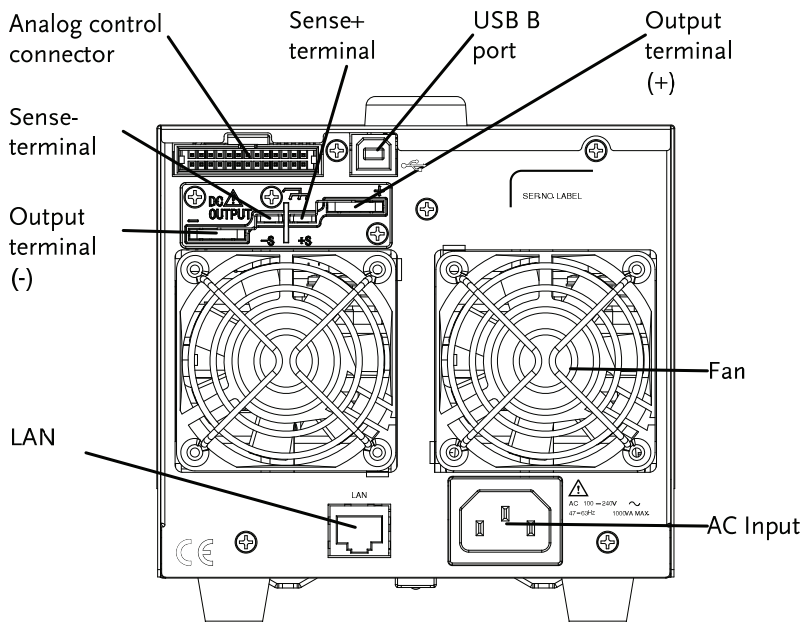

PSW 80-40.5, PSW 30-108 (1080W)

PSW 80-13.5,
PSW 30-36 (360W)

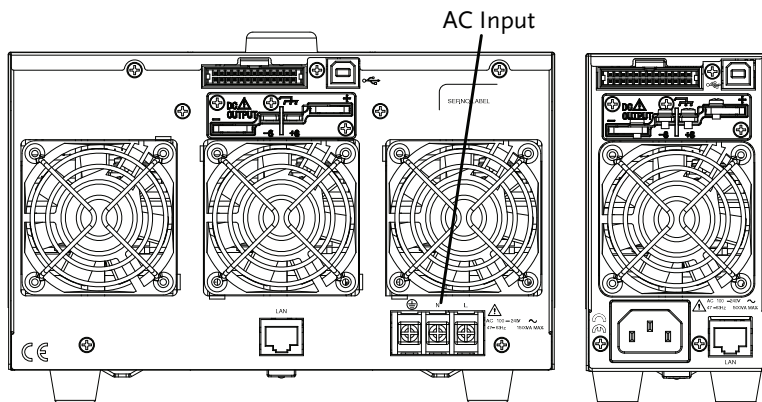

Analog Control Connector



Standard 26 pin MIL connector (OMRON XG4 IDC plug).

The analog control connector is used to monitor current and voltage output, machine status (OVP, OCP, OTP etc.), and for analog control of the current and voltage output.

Use an OMRON XG5 IDC socket as the mating socket.

Output Terminals



Positive (+) and negative (-) output terminals.



Chassis ground

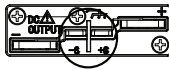

Sense (-) and Sense (+) terminals.

USB B port

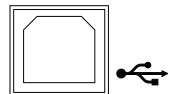

The USB B port is used for remote control.

Fans

Temperature controlled fans

Ethernet Port

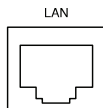

The ethernet port is used for remote control and digital monitoring from a PC.

Line Voltage
Input
(Type I/Type II)

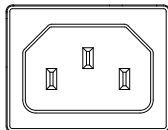

Type I: PSW 30-36/80-13.5

Type II: PSW 30-72/80-27

- Voltage Input: 100~240 VAC
- Line frequency: 50Hz/60 Hz (Automatically switchable)

Line Voltage
Input
(Type III)

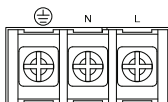

Type III: PSW 30-108/80-40.5

- Voltage Input: 100~240 VAC
- Line frequency: 50Hz/60 Hz (Automatically switchable)

Configuration Settings

Setting Configuration Settings

Background The normal configuration settings (F-01~F-61) are used to configure system settings. Use the following operation steps when configuring the interface settings used in the Remote Control chapter on page 18.

- Ensure the load is not connected.
- Ensure the output is off.



Note

Configuration settings F-90~F-95 cannot be edited in the Normal Function Settings. See the user manual for details.

Steps

1. Press the Function key. The function key will light up.

Function



2. The display will show F-01 on the top and the configuration setting for F-01 on the bottom.

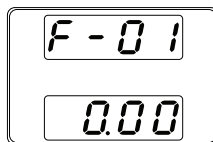

3. Rotate the voltage knob to change the F setting.

Range F-00~ F-61

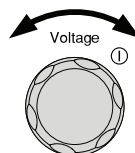

4. Use the current knob to set the parameter for the chosen F setting.

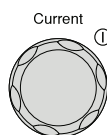

5. Press the Voltage knob to save the configuration setting. Conf will be displayed when successful.

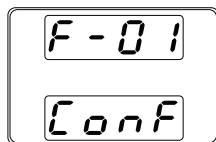
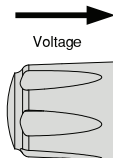

Exit

Press the Function key again to exit the configuration settings. The function key light will turn off.

Function



Configuration Table

Please use the configuration settings listed below when applying the configuration settings.

Normal Function Settings		
Settings	Setting	Setting Range
Output ON delay time	F-01	0.00s~99.99s
Output OFF delay time	F-02	0.00s~99.99s
V-I mode slew rate select	F-03	0 = CV high speed priority 1 = CC high speed priority 2 = CV slew rate priority 3 = CC slew rate priority
Rising voltage slew rate	F-04	0.01V/s~60.00V/s (PSW 30-XX) 0.1V/s~160.0V/s (PSW 80-XX)
Falling voltage slew rate	F-05	0.01V/s~60.00V/s (PSW 30-XX) 0.1V/s~160.0V/s (PSW 80-XX)
Rising current slew rate	F-06	0.01A/s~72.00A/s (PSW 30-36) 0.1A/s~144.0A/s (PSW 30-72) 0.1A/s~216.0A/s (PSW 30-108) 0.01A/s~27.00A/s (PSW 80-13.5) 0.01A/s~54.00A/s (PSW 80-27) 0.01A/s~81.00A/s (PSW 80-40.5)

Falling current slew rate	F-07	0.01A/s~72.00A/s (PSW 30-36)
		0.1A/s~144.0A/s (PSW 30-72)
		0.1A/s~216.0A/s (PSW 30-108)
		0.01A/s~27.00A/s (PSW 80-13.5)
		0.01A/s~54.00A/s (PSW 80-27)
		0.01A/s~81.00A/s (PSW 80-40.5)
Internal resistance setting	F-08	0.000Ω~0.833Ω (PSW 30-36)
		0.000Ω~0.417Ω (PSW 30-72)
		0.000Ω~0.278Ω (PSW 30-108)
		0.000Ω~5.926Ω (PSW 80-13.5)
		0.000Ω~2.963Ω (PSW 80-27)
		0.000Ω~1.975Ω (PSW 80-40.5)
Bleeder circuit control	F-09	0 = OFF, 1 = ON
Buzzer ON/OFF control	F-10	0 = ON, 1 = OFF
USB/GPIB settings		
Front panel USB State	F-20	0 = Absent, 1 = Mass Storage
Rear panel USB State	F-21	0 = Absent, 2 = USB-CDC, 3 = GPIB-USB adapter
Rear panel USB mode	F-22	0 = Disable, 1 = GPIB-USB adapter, 2 = USB CDC
GPIB address	F-23	0~30
LAN settings		
MAC Address-1	F-30	0x00~0xFF
MAC Address-2	F-31	0x00~0xFF
MAC Address-3	F-32	0x00~0xFF
MAC Address-4	F-33	0x00~0xFF
MAC Address-5	F-34	0x00~0xFF
MAC Address-6	F-35	0x00~0xFF
LAN	F-36	0 = Disable, 1 = Enable
DHCP	F-37	0 = Disable, 1 = Enable
IP Address-1	F-39	0~255
IP Address-2	F-40	0~255
IP Address-3	F-41	0~255
IP Address-4	F-42	0~255
Subnet Mask-1	F-43	0~255
Subnet Mask-2	F-44	0~255
Subnet Mask-3	F-45	0~255
Subnet Mask-4	F-46	0~255
Gateway-1	F-47	0~255
Gateway-2	F-48	0~255

Gateway-3	F-49	0~255
Gateway-4	F-50	0~255
DNS address -1	F-51	0~255
DNS address -2	F-52	0~255
DNS address-3	F-53	0~255
DNS address-4	F-54	0~255
Sockets active	F-57	0 = Disable, 1 = Enable
Web Server active	F-59	0 = Disable, 1 = Enable
Web password active	F-60	0 = Disable, 1 = Enable
Web setting password	F-61	0000~9999

RREMOTE CONTROL

This chapter describes basic configuration of IEEE488.2 based remote control. For a command list, refer to the programming manual, downloadable from GW Instek website, www.gwinstek.com

Interface Configuration	22
Command Syntax	26
Command List.....	29
Status Register Overview.....	63
Error List.....	75

Interface Configuration

USB Remote Interface	22
Configure GPIB Interface.....	23
Configure the Ethernet Interface	24
USB Remote Control Function Check.....	25
Web Server Remote Control Function Check.....	25

USB Remote Interface

USB configuration	PC side connector	Type A, host
	PSW side connector	Rear panel Type B, slave
	Speed	1.1/2.0 (full speed/high speed)
	USB Class	CDC (communications device class)

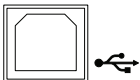
- Panel operation
1. Connect the USB cable to the rear panel USB B port. 
 2. Press the Function key to enter the Normal configuration settings. Page 17
- Set the following USB settings:
- F-22 = 2 Set the rear panel USB port to USB-CDC.

Configure GPIB Interface

To use GPIB, the optional GPIB to USB (GUG-001) adapter must be used. The GPIB to USB adapter must be connected before the PSW is turned on. Only one GPIB address can be used at a time.

- Configure GPIB
1. Ensure the PSW is off before proceeding.
 2. Connect the USB cable from the rear panel USB B port on the PSW to the USB A port on the GPIB to USB adapter.
 3. Connect a GPIB cable from a GPIB controller to the GPIB port on the adapter.

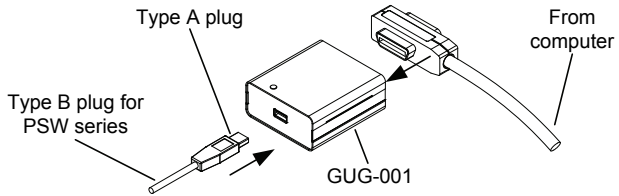

4. Turn the PSW on.
5. Press the Function key to enter the Page 17 Normal configuration settings.

Set the following GPIB settings:

- | | |
|-------------|---------------------------------------------------|
| F-22 = 1 | Set the rear panel USB port to GPIB-USB (GUG-001) |
| F-23 = 0~30 | Set the GPIB address (0~30) |
-

- GPIB constraints
- Maximum 15 devices altogether, 20m cable length, 2m between each device
 - Unique address assigned to each device
 - At least 2/3 of the devices turned On
 - No loop or parallel connection

Configure the Ethernet Interface

The Ethernet interface can be configured for a number of different applications. Ethernet can be configured for basic remote control or monitoring using a web server.

The PSW series supports DHCP connections so the instrument can be automatically connected to an existing network. Alternatively, network settings can also be manually configured.

Background	The Ethernet interface is used for remote control and monitoring over a network.	
Ethernet configuration Settings	MAC Address (display only)	LAN
	DHCP	IP Address
	Subnet Mask	Gateway
	DNS Address	Sockets Active
	Web Server Active	Web Password Active
	Web set password	0000~9999 (default 0000)

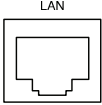
- | | | | | | | |
|-------------------------|-----------------------------------------------------------------------------------------------------------------------------------------------------------------------------------------------------------------------------------------------------------------------------------------------------------------------------------------------------------------------------------------------------------------------------------------------------------------------------------------------------------------|-----------------------------------------------------------------------------------|---------------------|----------|------------------------|--|
| Connection | <ol style="list-style-type: none"> 1. Connect an Ethernet cable from the network to the rear panel Ethernet port. |  | | | | |
| DHCP Connection Example | <ol style="list-style-type: none"> 2. Use the Following configuration settings to use Dynamic Host Configuration Protocol. The following settings will also automatically assign an IP address. 3. Press the Function key to enter the Page 17 following LAN configuration settings. <table border="0" style="margin-left: 20px;"> <tr> <td>F-37 = 1</td> <td>Turn DHCP to enable</td> </tr> <tr> <td>F-59 = 1</td> <td>Turn the web server on</td> </tr> </table> | F-37 = 1 | Turn DHCP to enable | F-59 = 1 | Turn the web server on | |
| F-37 = 1 | Turn DHCP to enable | | | | | |
| F-59 = 1 | Turn the web server on | | | | | |

 **Note**

It may be necessary to cycle the power or refresh the web browser to connect to a network.

USB Remote Control Function Check

Functionality
check

Invoke a terminal application such as Hyper Terminal.

To check the COM port No, see the Device Manager in the PC. For WinXP; Control panel → System → Hardware tab.

Run this query command via the terminal after the instrument has been configured for USB remote control (page 22).

*idn?

This should return the Manufacturer, Model number, Serial number, and Firmware version in the following format.

```
GW-INSTEK,PSW-3036,TW123456,01.00.20110101
```

```
Manufacturer: GW-INSTEK
```

```
Model number : PSW-3036
```

```
Serial number : TW123456
```

```
Firmware version : 01.00.20110101
```

- ^j can be used as the terminal character when entering the queries/commands from a terminal application.

Web Server Remote Control Function Check

Functionality
check

Enter the IP address of the power supply in a web browser after the instrument has been configured as a web server (page 24).

```
http:// XXX.XXX.XXX.XXX
```

The web browser interface appears.

Command Syntax

Compatible Standard	IEEE488.2	Partial compatibility
	SCPI, 1999	Partial compatibility

Command Structure SCPI commands follow a tree-like structure, organized into nodes. Each level of the command tree is a node. Each keyword in a SCPI command represents each node in the command tree. Each keyword (node) of a SCPI command is separated by a colon (:).

For example, the diagram below shows an SCPI sub-structure and a command example.

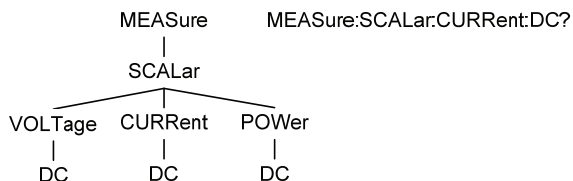

Command types There are a number of different instrument commands and queries. A command sends instructions or data to the unit and a query receives data or status information from the unit.

Command types

Simple A single command with/without a parameter

Example *IDN?

Query	A query is a simple or compound command followed by a question mark (?). A parameter (data) is returned.
Example	meas:curr:dc?
Compound	<p>Two or more commands on the same command line. Compound commands are separated with either a semi-colon (;) or a semi-colon and a colon (;).</p> <p>A semi-colon is used to join two related commands, with the caveat that the last command must begin at the last node of the first command.</p> <p>A semi-colon and colon are used to combine two commands from different nodes.</p>
Example	meas:volt:dc?;;meas:curr:dc?

Command Forms Commands and queries have two different forms, long and short. The command syntax is written with the short form of the command in capitals and the remainder (long form) in lower case.

The commands can be written in capitals or lower-case, just so long as the short or long forms are complete. An incomplete command will not be recognized.

Below are examples of correctly written commands.

Long form	STATus:OPERation:NTRansition? STATUS:OPERATION:NTRANSITION? status:operation:ntransition?
Short form	STAT:OPER:NTR? stat:oper:ntr?

Square Brackets Commands that contain square brackets indicate that the contents are optional. The function of the command is the same with or without the square bracketed items, as shown below.

Both “DISPlay:MENU[:NAME]?” and “DISPlay:MENU?” are both valid forms.

Command Format	APPLY 1.5,5.2 	1. Command header 2. Space 3. Parameter 1 4. Comma (no space before/after comma) 5. Parameter 2
-----------------------	----------------------	-------------------------------------------------------------------------------------------------------------

Parameters	Type	Description	Example
	<Boolean>	Boolean logic	0, 1

<NR1>	integers	0, 1, 2, 3
<NR2>	decimal numbers	0.1, 3.14, 8.5
<NR3>	floating point	4.5e-1, 8.25e+1
<NRF>	any of NR1, 2, 3	1, 1.5, 4.5e-1

Message Terminator	LF	Line feed code
--------------------	----	----------------

Command List

Abort Commands	ABORt	32
Apply Commands	APPLy	32
Display Commands	DISPlay:MENU[:NAME]	33
	DISPlay[:WINDow]:TEXT:CLear	34
	DISPlay[:WINDow]:TEXT[:DATA]	34
	DISPlay:BLINK	34
Initiate Commands	INITiate[:IMMediate]:NAME	35
Measure Commands	MEASure[:SCALar]:CURRent[:DC]	35
	MEASure[:SCALar]:VOLTage[:DC]	36
	MEASure[:SCALar]:POWer[:DC]	36
Output Commands	OUTPut:DELAy:ON	36
	OUTPut:DELAy:OFF	37
	OUTPut:MODE	37
	OUTPut[:STATe][:IMMediate]	37
	OUTPut[:STATe]:TRIGgered	38
	OUTPut:PROTection:CLear	38
	OUTPut:PROTection:TRIPped	38

Status	STATus:OPERation[:EVENt]	39
Commands	STATus:OPERation:CONDition	39
	STATus:OPERation:ENABle	39
	STATus:OPERation:PTRansition.....	40
	STATus:OPERation:NTRansition.....	40
	STATus:QUEStionable[:EVENt]	40
	STATus:QUEStionable:CONDition	41
	STATus:QUEStionable:ENABle	41
	STATus:QUEStionable:PTRansition.....	41
	STATus:QUEStionable:NTRansition.....	41
	STATus:PRESet	42
Source	[SOURce:]CURRent[:LEVel][:IMMediate][:AMPLitude] 43	
Commands	[SOURce:]CURRent[:LEVel]:TRIGgered[:AMPLitude]..	44
	[SOURce:]CURRent:PROTection[:LEVel]	44
	[SOURce:]CURRent:SLEW:RISing	45
	[SOURce:]CURRent:SLEW:FALLing.....	45
	[SOURce:]RESistance[:LEVel][:IMMediate] [:AMPLitude].....	46
	[SOURce:]VOLTag[:LEVel][:IMMediate][:AMPLitude] 46	
	[SOURce:]VOLTag[:LEVel]:TRIGgered[:AMPLitude] .	47
	[SOURce:]VOLTag:PROTection[:LEVel]	47
	[SOURce:]VOLTag:SLEW:RISing.....	47
	[SOURce:]VOLTag:SLEW:FALLing	48
Trigger	TRIGger:TRANsient[:IMMediate].....	48
Commands	TRIGger:TRANsient:SOURce	49
	TRIGger:OUTPut[:IMMediate]	49
	TRIGger:OUTPut:SOURce.....	49
System	SYSTem:CONFigure:BEEPer:STATe	51
Commands	SYSTem:CONFigure:BLEeder:STATe.....	52
	SYSTem:CONFigure:BTRip[:IMMediate]	52
	SYSTem:CONFigure:BTRip:PROTection	52
	SYSTem:CONFigure:CURRent:CONTRol.....	53
	SYSTem:CONFigure:VOLTag:CONTRol	53
	SYSTem:CONFigure:MSLave	53
	SYSTem:CONFigure:OUTPut:EXTernal:MODE.....	54
	SYSTem:CONFigure:OUTPut:PON[:STATe]	54
	SYSTem:COMMunicate:ENABle.....	55

	SYSTem:COMMunicate:GPIB[:SELF]:ADDRess	56
	SYSTem:COMMunicate:LAN:IPADdress	56
	SYSTem:COMMunicate:LAN:GATEway	56
	SYSTem:COMMunicate:LAN:SMASk	56
	SYSTem:COMMunicate:LAN:MAC	57
	SYSTem:COMMunicate:LAN:DHCP	57
	SYSTem:COMMunicate:LAN:DNS	57
	SYSTem:COMMunicate:USB:FRONT:STATe	58
	SYSTem:COMMunicate:USB:REAR:STATe	58
	SYSTem:ERRor	58
	SYSTem:KLOCK	58
	SYSTem:VERSion	59
Common	*CLS	60
Commands	*ESE	60
	*ESR	60
	*IDN	60
	*OPC	61
	*RST	61
	*SRE	61
	*STB	62
	*TRG	62
	*TST	62
	*WAI	62

Abort Commands

ABORt32

ABORt (Set) →

Description	The ABORt command will cancel any triggered actions.
Syntax	ABORt

APPLY Commands

APPLY32

APPLY (Set) → → (Query)

Description	<p>The APPLY command is used to set both the voltage and current. The voltage and current will be output as soon as the function is executed if the programmed values are within the accepted range. An execution error will occur if the programmed values are not within accepted ranges.</p> <p>The Apply command will set the voltage/current values but these values will not be reflected on the display until the Output is On or if the DISPlay:MENU:NAME 3 (set menu) command is used.</p>	
Syntax	<p>APPLY {<voltage> MIN MAX}[,{<current> MIN MAX}] APPLY?</p>	
Parameter	<voltage>	<NRf> 0% ~ 105% of the rated output voltage.
	<current>	<NRf> 0% ~ 105% of the rated output current.
	MIN	0 volts/0 amps

	MAX	Maxium value for the present range.
Return parameter	<NRf>	Returns the voltage and current.
Example	APPL 5.05,1.1	Sets the voltage and current to 5.05V and 1.1A.
Query Example	APPL?	+5.050, +1.100 Returns voltage (5.05V) and current (1.1A) setting.

Display Commands

DISPlay:MENU[:NAME]33
DISPlay[:WINDow]:TEXT:CLear34
DISPlay[:WINDow]:TEXT[:DATA]34
DISPlay:BLINK34

DISPlay:MENU[:NAME]

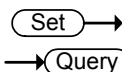

Description	The DISPlay MENU command selects a screen menu or queries the current screen menu.	
Syntax	DISPlay:MENU[:NAME] <NR1>	
Query Sytax	DISPlay:MENU[:NAME]?	
Parameter/ Return parameter	<NR1>	Description
	0	Measurement-Voltage / Measurement-Current
	1	Measurement-Voltage / Measurement-Power
	2	Measurement-Power / Measurement-Current
	3	Set Menu
	4	OVP / OCP Menu
	5~99	Not Used.
	100~199	F-00~99 Menu.
Example	DISP:MENU:NAME 0 Sets the display to the Voltage/Current display screen.	

DISPlay[:WINDow]:TEXT:CLEar (Set) →

Description	Clears the text on the main screen from the DISPlay[:WINDow]:TEXT[:DATA] command .
Syntax	DISPlay[:WINDow]:TEXT:CLEar

DISPlay[:WINDow]:TEXT[:DATA] (Set) →
→ (Query)

Description	Sets or queries the data text that will be written to the display. Writing to the display will overwrite data that is currently on the screen. Overwriting a display area with a shorter string may or may not overwrite the screen. The string must be enclosed in quotes: "STRING". Only ASCII characters 20H to 7EH can be used in the <string>.
Syntax	DISPlay[:WINDow]:TEXT[:DATA] <string>
Query Syntax	DISPlay[:WINDow]:TEXT[:DATA]?
Parameter/ Return parameter	<string> ASCII character 20H to 7EH can be used to in the string parameter. The string must be enclosed in quotes: "STRING"
Example	DISP:WIND:TEXT:DATA "STRING" Writes STRING to the display.
Query Example	DISP:WIND:TEXT:DATA? "STRING" Returns the text data string on the screen.

DISPlay:BLINK (Set) →
→ (Query)

Description	Turns blink on or off for the display.
Syntax	DISPlay:BLINK { 0 1 OFF ON }
Query Syntax	DISPlay:BLINK?
Parameter	0 <NR1>Turns blink OFF OFF Turns blink OFF 1 <NR1> Turns blink ON

	ON	Turns blink ON
Return parameter	0	<NR1>Turns blink OFF
	1	<NR1>Turns blink ON
Example	DISP:BLIN 1 Turns blink ON.	

Initiate Commands

INITiate[:IMMEDIATE]:NAME35

INITiate[:IMMEDIATE]:NAME (Set) →

Description	The INITiate command starts the TRANsient or OUTPut trigger.	
Syntax	INITiate[:IMMEDIATE]:NAME {TRANsient OUTPut}	
Parameter	TRANsient	Starts the TRANsient trigger.
	OUTPut	Starts the OUTPut trigger.
Example	INITiate:NAME TRANient Starts the TRANsient trigger.	

Measure Commands

MEASure[:SCALAR]:CURRent[:DC]35
 MEASure[:SCALAR]:VOLTage[:DC]36
 MEASure[:SCALAR]:POWer[:DC]36

MEASure[:SCALAR]:CURRent[:DC] → (Query)

Description	Takes a measurement and returns the average output current	
Syntax	MEASure[:SCALAR]:CURRent[:DC]?	
Return parameter	<NRf>	Returns the current in amps.

MEASure[:SCALar]:VOLTage[:DC] → **Query**

Description	Takes a measurement and returns the average output voltage.
Syntax	MEASure[:SCALar]:VOLTage[:DC]?
Return	<NRf> Returns the voltage in volts.

MEASure[:SCALar]:POWer[:DC] → **Query**

Description	Takes a measurement and returns the average output power.
Syntax	MEASure[:SCALar]:POWer[:DC]?
Return	<NRf> Returns the power measured in watts.

Output Commands

OUTPut:DELAy:ON	36
OUTPut:DELAy:OFF	37
OUTPut:MODE	37
OUTPut[:STATe][:IMMediate]	37
OUTPut[:STATe]:TRIGgered.....	38
OUTPut:PROTection:CLEar	38
OUTPut:PROTection:TRIPped.....	38

OUTPut:DELAy:ON

Set →
 → Query

Description	Sets the Delay Time in seconds for turning the output on. The delay is set to 0.000 by default.
Syntax	OUTPut:DELAy:ON <NRf>
Query Syntax	OUTPut:DELAy:ON?
Parameter	<NRf> 0.00~99.99 seconds, where 0=no delay.
Return parameter	<NRf> Returns the delay on time in seconds until the output is turned on.

Set →

→ Query

OUTPut:DElay:OFF

Description	Sets the Delay Time in seconds for turning the output off. The delay is set to 0.000 by default.	
Syntax	OUTPut:DElay:OFF <NRf>	
Return Syntax	OUTPut:DElay:OFF?	
Parameter	<NRf>	0.00~99.99 seconds, where 0=no delay.
Return parameter	<NRf>	Returns the delay off time in seconds until the output is turned off.

Set →

→ Query

OUTPut:MODE

Description	Sets the PSW output mode. This is the equivalent to the F-03 (V-I Mode Slew Rate Select) settings.	
Syntax	OUTPut:MODE {<NR1> CVHS CCHS CVLS CCLS}	
Return Syntax	OUTPut:MODE?	
Parameter	0	CV high speed priority
	CVHS	CV high speed priority
	1	CC high speed priority
	CCHS	CC high speed priority
	2	CV slew rate priority
	CVLS	CV slew rate priority
	3	CC slew rate priority
	CCLS	CC slew rate priority
Return parameter	<NR1>	Returns the output mode.

Set →

→ Query

OUTPut[:STATe][:IMMediate]

Description	Turns the output on or off.	
Syntax	OUTPut[:STATe][:IMMediate] { OFF ON 0 1 }	
Query Syntax	OUTPut[:STATe][:IMMediate]?	
Parameter	0	<NR1> Turns the output off.
	OFF	Turns the output off.
	1	<NR1> Turns the output on.

	ON	Turns the output on.
Return parameter	<NR1>	Returns output status of the instrument.

OUTPut[:STATe]:TRIGgered (Set) →
→ (Query)

Description	Turns the output on or off when a software trigger is generated.	
Syntax	OUTPut[:STATe]:TRIGgered { OFF ON 0 1 }	
Query Syntax	OUTPut[:STATe]:TRIGgered?	
Parameter	0	<NR1>Turns the output off when a software trigger is generated.
	OFF	Turns the output off when a software trigger is generated.
	1	<NR1>Turns the output on when a software trigger is generated.
	ON	Turns the output on when a software trigger is generated.
Return parameter	<NR1>	Returns output trigger status of the instrument.

OUTPut:PROTection:CLEar (Set) →

Description	Clears over-voltage, over-current and over-temperature (OVP, OCP, OTP) protection circuits. It also clears the shutdown protection circuit. The AC failure protection cannot be cleared.	
Syntax	OUTPut:PROTection:CLEar	

OUTPut:PROTection:TRIPped → (Query)

Description	Returns the state of the protection circuits (OVP, OCP, OTP).	
Query Syntax	OUTPut:PROTection:TRIPped?	
Return parameter	0	<NR1>Protection circuits are not tripped.
	1	<NR1>Protection circuits are tripped.

Status Commands

STATus:OPERation[:EVENT]	39
STATus:OPERation:CONDition	39
STATus:OPERation:ENABle	39
STATus:OPERation:PTRansition	40
STATus:OPERation:NTRansition	40
STATus:QUEStionable[:EVENT]	40
STATus:QUEStionable:CONDition	41
STATus:QUEStionable:ENABle	41
STATus:QUEStionable:PTRansition	41
STATus:QUEStionable:NTRansition	41
STATus:PRESet	42

STATus:OPERation[:EVENT] → Query

Description Queries the Operation Status Event register and clears the contents of the register.

Syntax STATus:OPERation[:EVENT]?

Return <NR1> Returns the bit sum of the Operation Status Event register.

STATus:OPERation:CONDition → Query

Description Queries the Operation Status register. This query will not clear the register.

Syntax STATus:OPERation:CONDition?

Return <NR1> Returns the bit sum of the Operation Condition register.

Set →

STATus:OPERation:ENABle → Query

Description Sets or queries the bit sum of the Operation Status Enable register.

Syntax STATus:OPERation:ENABle <Nrf>

Query Syntax STATus:OPERation:ENABle?

Parameter <Nrf> 0~32767

Return parameter <NR1> 0~32767

Set →

→ Query

STATus:OPERation:PTRansition

Description Sets or queries the bit sum of the positive transition filter of the Operation Status register.

Syntax STATus:OPERation:PTRansition <Nrf>

 STATus:OPERation:PTRansition?

Parameter <Nrf> 0~32767

Return parameter <NR1> 0~32767

Set →

→ Query

STATus:OPERation:NTRansition

Description Sets or queries the bit sum of the negative transition filter of the Operation Status register.

Syntax STATus:OPERation:NTRansition <Nrf>

Query Syntax STATus:OPERation:NTRansition?

Parameter <Nrf> 0~32767

Return parameter <NR1> 0~32767

STATus:QUESTIONable[:EVENT]

→ Query

Description Queries the bit sum of the Questionable Status Event register. This query will also clear the contents of the register.

Query Syntax STATus:QUESTIONable[:EVENT]?

Parameter <Nrf> 0~32767

Return parameter <NR1> 0~32767

STATus:QUEStionable:CONDition → **Query**

Description Queries the status (bit sum) of the Questionable Status register. This query will not clear the register.

Query Syntax STATus:QUEStionable:CONDition?

Parameter <NRf> 0~32767

Return parameter <NR1> 0~32767

→ **Set**

STATus:QUEStionable:ENABle → **Query**

Description Sets or queries the bit sum of the Questionable Status Enable register.

Syntax STATus:QUEStionable:ENABle <NRf>

Query Syntax STATus:QUEStionable:ENABle?

Parameter <NRf> 0~32767

Return parameter <NR1> 0~32767

→ **Set**

STATus:QUEStionable:PTRansition → **Query**

Description Sets or queries the bit sum of the positive transition filter of the Questionable Status register.

Syntax STATus:QUEStionable:PTRansition <NRf>

Return Syntax STATus:QUEStionable:PTRansition?

Parameter <NRf> 0~32767

Return parameter <NR1> 0~32767

→ **Set**

STATus:QUEStionable:NTRansition → **Query**

Description Sets or queries the negative transition filter of the Questionable Status register.

Syntax STATus:QUEStionable:NTRansition <NRf>

Query Syntax STATus:QUEStionable:NTRansition?

Parameter	<NRf>	0~32767
Return parameter	<NR1>	0~32767

STATus:PRESet



Description This command resets the ENABLE register, the PTRansition filter and NTRansition filter on the Operation Status and Questionable Status Registers. The registers/filters will be reset to a default value.

Default Register/Filter Values	Setting
QUEStionable Status Enable	0x0000
QUEStionable Status Positive Transition	0x7FFF
QUEStionable Status Negative Transition	0x0000
Operation Status Enable	0x0000
Operation Status Positive Transition	0x7FFF
Operation Status Negative Transition	0x0000

Summary: The Questionable Status Enable registers and the Operation Status Enable registers are both reset to 0.

The Questionable Status and Operation Status Positive Transition filters are all set high (0x7FFF) and the Negative Transition filters are all set low (0x0000). I.e., only positive transitions will be recognized for the Questionable Status and Operation Status registers.

Syntax STATus:PRESet

Source Commands

[SOURce:]CURRent[:LEVel][:IMMediate][:AMPLitude]	43
[SOURce:]CURRent[:LEVel]:TRIGgered[:AMPLitude]	44
[SOURce:]CURRent:PROTection[:LEVel]	44
[SOURce:]CURRent:SLEW:RISing	45
[SOURce:]CURRent:SLEW:FALLing	45
[SOURce:]REStance[:LEVel][:IMMediate][:AMPLitude]	46
[SOURce:]VOLTage[:LEVel][:IMMediate][:AMPLitude]	46
[SOURce:]VOLTage[:LEVel]:TRIGgered[:AMPLitude]	47
[SOURce:]VOLTage:PROTection[:LEVel]	47
[SOURce:]VOLTage:SLEW:RISing	47
[SOURce:]VOLTage:SLEW:FALLing	48

[SOURce:]CURRent[:LEVel][:IMMediate] Set →
[:AMPLitude] ←Query

Description	Sets or queries the current level in amps. For externally set current levels (from the analog control connector) the set current level is returned.						
Syntax	[SOURce:]CURRent[:LEVel][:IMMediate][:AMPLitude] {<NRf> MIN MAX}						
Query Syntax	[SOURce:]CURRent[:LEVel][:IMMediate][:AMPLitude]? {MIN MAX}						
Parameter/Return	<table> <tr> <td><NRf></td> <td>0~105% of the rated current output level.</td> </tr> <tr> <td>MIN</td> <td>Minimum current level.</td> </tr> <tr> <td>MAX</td> <td>Maximum current level.</td> </tr> </table>	<NRf>	0~105% of the rated current output level.	MIN	Minimum current level.	MAX	Maximum current level.
<NRf>	0~105% of the rated current output level.						
MIN	Minimum current level.						
MAX	Maximum current level.						
Example	<p>SOUR:CURR:LEV:IMM:AMPL? MAX</p> <p>37.800</p> <p>Returns the maximum possible current level in amps.</p>						

[SOURce:]CURRent[:LEVel]:TRIGgered (Set) →
 [:AMPLitude] → (Query)

Description	Sets or queries the current level in amps when a software trigger has been generated.	
Syntax	[SOURce:]CURRent[:LEVel]:TRIGgered[:AMPLitude] {<NRf> MIN MAX}	
Query Syntax	[SOURce:]CURRent[:LEVel]:TRIGgered[:AMPLitude]? {<NRf> MIN MAX}	
Parameter/Return	<NRf>	0%~105% of the rated current output in amps.
	MIN	Minimum current level.
	MAX	Maximum current level.
Example	SOUR:CURR:LEV:TRIG:AMPL? MAX 37.800 Returns the maximum possible current level in amps.	

[SOURce:]CURRent:PROTection[:LEVel] (Set) →
→ (Query)

Description	Sets or queries the OCP (over-current protection) level in amps.	
Syntax	[SOURce:]CURRent:PROTection[:LEVel] {<NRf> MIN MAX}	
Query Syntax	[SOURce:]CURRent:PROTection[:LEVel]? {MIN MAX}	
Parameter/Return	<NRf>	10%~110% of the rated current output level.
	MIN	Minimum current level.
	MAX	Maximum current level.
Example	SOUR:CURR:PROT:LEV? MIN +3.600 Returns the minimum possible current level in amps.	

[SOURce:]CURRent:SLEW:RISing
 Set →
 Query

Description	Sets or queries the rising current slew rate. This is only applicable for CC slew rate priority mode.	
Syntax	[SOURce:]CURRent:SLEW:RISing {<NRf> MIN MAX}	
Query Syntax	[SOURce:]CURRent:SLEW:RISing? {MIN MAX}	
Parameter/Return	<NRf>	0.01A/s~200% (PSW 30-36) 0.1A/s~200% (PSW 30-72) 0.1A/s~200% (PSW 30-108) 0.01A/s~200% (PSW 80-13.5) 0.01A/s~200% (PSW 80-27) 0.01A/s~200% (PSW 80-40.5)
	MIN	Minimum rising current slew rate.
	MAX	Maximum rising current slew rate.

Example SOUR:CURR:SLEW:RIS 72
 Sets the rising current slew rate to 72A/s.

[SOURce:]CURRent:SLEW:FALLing
 Set →
 Query

Description	Sets or queries the falling current slew rate. This is only applicable for CC slew rate priority mode.	
Syntax	[SOURce:]CURRent:SLEW:FALLing {<NRf> MIN MAX}	
Query Syntax	[SOURce:]CURRent:SLEW:FALLing? {MIN MAX}	
Parameter/Return	NRf	0.01A/s~200% (PSW 30-36) 0.1A/s~200% (PSW 30-72) 0.1A/s~200% (PSW 30-108) 0.01A/s~200% (PSW 80-13.5) 0.01A/s~200% (PSW 80-27) 0.01A/s~200% (PSW 80-40.5)
	MIN	Minimum falling current slew rate
	MAX	Maximum falling current slew rate

Example SOUR:CURR:SLEW:FALL 1
 Sets the falling current slew rate to 1A/s.

[SOURce:]RESistance[:LEVel][:IMMEDIATE] Set →
 [:AMPLitude] ← Query

Description	Sets or queries the internal resistance in ohms.	
Syntax	[SOURce:]RESistance[:LEVel][:IMMEDIATE][:AMPLitude] {<NRF> MIN DEF MAX ?}	
Query Syntax	[SOURce:]RESistance[:LEVel][:IMMEDIATE][:AMPLitude] ? {MIN MAX}	
Parameter/Return	<NRF>	Resistance in ohms: 0.000Ω~0.833Ω (PSW 30-36) 0.000Ω~0.417Ω (PSW 30-72) 0.000Ω~0.278Ω (PSW 30-108) 0.000Ω~5.926Ω (PSW 80-13.5) 0.000Ω~2.963Ω (PSW 80-27) 0.000Ω~1.975Ω (PSW 80-40.5)
	MIN	Minimum internal resistance in ohms
	MAX	Maximum internal resistance in ohms

Example SOUR:RES:LEV:IMM:AMPL 0.1
 Sets the internal resistance to 100mΩ.

[SOURce:]VOLTage[:LEVel][:IMMEDIATE] Set →
 [:AMPLitude] ← Query

Description	Sets or queries the voltage level in volts.	
Syntax	[SOURce:]VOLTage[:LEVel][:IMMEDIATE][:AMPLitude] {<NRF> MIN MAX}	
Query Syntax	[SOURce:]VOLTage[:LEVel][:IMMEDIATE][:AMPLitude]? {MIN MAX}	
Parameter/Return	<NRF>	0~105% of the rated output voltage in volts.
	MIN	Minimum voltage level
	MAX	Maximum voltage level

Example SOUR:VOLT:LEV:IMM:AMPL 10
 Sets the voltage level to 10 volts.

[SOURce:]VOLTage[:LEVel]:TRIGgered (Set) →
 [:AMPLitude] → (Query)

Description	Sets or queries the voltage level in volts when a software trigger has been generated.	
Syntax	[SOURce:]VOLTage[:LEVel]:TRIGgered[:AMPLitude] {<NRf> MIN MAX}	
Query Syntax	[SOURce:]VOLTage[:LEVel]:TRIGgered[:AMPLitude]? {<NRf> MIN MAX}	
Parameter/Return	<NRf>	0%~105% of the rated voltage output in volts. MIN Minimum current level. MAX Maximum current level.
Example	SOUR:VOLT:LEV:TRIG:AMPL 10 Sets the voltage level to 10 volts when a software trigger is generated.	

[SOURce:]VOLTage:PROTection[:LEVel] (Set) →
→ (Query)

Description	Sets or queries the overvoltage protection level.	
Syntax	[SOURce:]VOLTage:PROTection[:LEVel] {<NRf> MIN MAX}	
Query Syntax	[SOURce:]VOLTage:PROTection[:LEVel]? {MIN MAX}	
Parameter/Return	<NRf>	10%~110% of the rated output voltage in volts. MIN Minimum OVP level MAX Maximum OVP level
Example	SOUR:VOLT:PROT:LEV MAX Sets the OVP level to its maximum.	

[SOURce:]VOLTage:SLEW:RISing (Set) →
→ (Query)

Description	Sets or queries the rising voltage slew rate. This is only applicable for CV slew rate priority mode.	
-------------	-------------------------------------------------------------------------------------------------------	--

Syntax	[SOURce:]VOLTage:SLEW:RISing {<NRf> MIN MAX}
Query Syntax	[SOURce:]VOLTage:SLEW:RISing? {MIN MAX}
Parameter/Return	<NRf> 0.01V/s--200% (PSW 30-XX) 0.1V/s--200% (PSW 80-XX) MIN Minimum rising voltage slew rate. MAX Maximum rising voltage slew rate.

Example SOUR:VOLT:SLEW:RIS MAX
Sets the rising voltage slew rate to its maximum.

Set →

[SOURce:]VOLTage:SLEW:FALLing

→ Query

Description	Sets or queries the falling voltage slew rate. This is only applicable for CV slew rate priority mode.
Syntax	[SOURce:]VOLTage:SLEW:FALLing {<NRf> MIN MAX}
Query Syntax	[SOURce:]VOLTage:SLEW:FALLing? {MIN MAX}
Parameter/Return	<NRf> 0.01V/s--200% (PSW 30-XX) 0.1V/s--200% (PSW 80-XX) MIN Minimum voltage falling slew rate. MAX Maximum voltage falling slew rate.

Example SOUR:VOLT:SLEW:FALL MIN
Sets the falling voltage slew rate to its minimum.

Trigger Commands

The trigger commands generate and configure software triggers.

TRIGger:TRANsient[:IMMEDIATE].....	48
TRIGger:TRANsient:SOURce.....	49
TRIGger:OUTPut[:IMMEDIATE].....	49
TRIGger:OUTPut:SOURce.....	49

Set →

TRIGger:TRANsient[:IMMEDIATE]

→ Query

Description	Generates a software trigger for the transient trigger system.
-------------	----------------------------------------------------------------

Syntax TRIGger:TRANSient[:IMMEDIATE]

Set →

TRIGger:TRANSient:SOURce

→ Query

Description Sets or queries the trigger source for the transient system.

Syntax TRIGger:TRANSient:SOURce {BUS | IMMEDIATE}

Query Syntax TRIGger:TRANSient:SOURce?

Parameter/Return	BUS	Internal software trigger. Waits for the *TRG (or IEEE 488.1 "get" group execute trigger) command to start the trigger.
	IMMEDIATE	Starts the trigger immediately. (default)

Example TRIG:TRAN:SOUR BUS
Sets the trigger source as BUS.

TRIGger:OUTPut[:IMMEDIATE]

Set →

Description Generates a software trigger for the output trigger system.

Syntax TRIGger:OUTPut[:IMMEDIATE]

Set →

TRIGger:OUTPut:SOURce

→ Query

Description Sets or queries the trigger source for the output system.

Syntax TRIGger:OUTPut:SOURce {BUS | IMMEDIATE | EXTERNAL}

Query Syntax TRIGger:OUTPut:SOURce?

Parameter/Return	BUS	Internal software trigger. Waits for the *TRG (or IEEE 488.1 "get" group execute trigger) command to start the trigger.
	IMMEDIATE	Starts the trigger immediately. (default)

Example

TRIG:OUTP:SOUR BUS

Sets the trigger source of the output system as BUS.

System Function Command

SYSTem:CONFIgure:BEEPer:STATe 51
 SYSTem:CONFIgure:BLEeder:STATe 52
 SYSTem:CONFIgure:BTrip[:IMMediate] 52
 SYSTem:CONFIgure:BTrip:PROTection 52
 SYSTem:CONFIgure:CURRent:CONTRol 53
 SYSTem:CONFIgure:VOLTAge:CONTRol 53
 SYSTem:CONFIgure:MSLave 53
 SYSTem:CONFIgure:OUTPut:EXTernal:MODE 54
 SYSTem:CONFIgure:OUTPut:PON[:STATe] 54
 SYSTem:COMMunicate:ENABle 55
 SYSTem:COMMunicate:GPIB[:SELF]:ADDReSS 56
 SYSTem:COMMunicate:LAN:IPADdress 56
 SYSTem:COMMunicate:LAN:GATEway 56
 SYSTem:COMMunicate:LAN:SMASk 56
 SYSTem:COMMunicate:LAN:MAC 57
 SYSTem:COMMunicate:LAN:DHCP 57
 SYSTem:COMMunicate:LAN:DNS 57
 SYSTem:COMMunicate:USB:FRONT:STATe 58
 SYSTem:COMMunicate:USB:REAR:STATe 58
 SYSTem:ERRor 58
 SYSTem:KLOCK 58
 SYSTem:VERSIon 59

SYSTem:CONFIgure:BEEPer:STATe



Description	Sets or queries the buzzer state on/off.	
Syntax	SYSTem:CONFIgure:BEEPer[:STATe] {OFF ON 0 1}	
Query Syntax	SYSTem:CONFIgure:BEEPer[:STATe]?	
Parameter	0	<NR1> Turns the buzzer off.
	OFF	Turns the buzzer off.
	1	<NR1> Turns the buzzer on.
	ON	Turns the buzzer on.
Return parameter	<Boolean>	Returns the buzzer status.

SYSTEM:CONFigure:BLEeder:STATe (Set) →
→ (Query)

Description	Sets or queries the status of the bleeder resistor.	
Syntax	SYSTEM:CONFigure:BLEeder[:STATe] {OFF ON 0 1}	
Query Syntax	SYSTEM:CONFigure:BLEeder[:STATe]?	
Parameter	0	<NR1> Turns the bleeder resistor off.
	OFF	Turns the bleeder resistor off.
	1	<NR1> Turns the bleeder resistor on.
	ON	Turns the bleeder resistor on.
Return parameter	<Boolean>	Returns bleeder resistor status.

SYSTEM:CONFigure:BTRip[:IMMEDIATE] (Set) →

Description	Trips the power switch trip (circuit breaker) to turn the unit off (shut down the power).	
Syntax	SYSTEM:CONFigure:BTRip[:IMMEDIATE]	

SYSTEM:CONFigure:BTRip:PROTECTION (Set) →
→ (Query)

Description	Enables/Disables the power switch trip (circuit breaker) when the OVP or OCP protection settings are tripped. This setting only applies after power has been reset.	
Syntax	SYSTEM:CONFigure:BTRip:PROTECTION {OFF ON 0 1}	
Query Syntax	SYSTEM:CONFigure:BTRip:PROTECTION?	
Parameter	0	<NR1> Disables the power switch trip for OVP or OCP.
	OFF	Disables the power switch trip for OVP or OCP.
	1	<NR1> Enables the power switch trip for OVP or OCP.
	ON	Enables the power switch trip for OVP or OCP.
Return parameter	<Boolean>	Returns power switch trip setting.

SYSTEM:CONFigure:CURRent:CONTRol
 →
 →

Description Sets or queries the CC control mode (local control (panel), external voltage control, external resistance control). This setting is applied only after the unit is reset.

Syntax SYSTEM:CONFigure:CURRent:CONTRol { 0 | 1 | 2 | 3 }

Query Syntax SYSTEM:CONFigure:CURRent:CONTRol?

Parameter/Return	<NR1>	Description
	0	Local (Panel) control
	1	External voltage control
	2	External resistance control; 10kΩ = Io max, 0kΩ = Io min.
	3	External resistance control; 10kΩ = Io min, 0kΩ = Io max.

SYSTEM:CONFigure:VOLTage:CONTRol
 →
 →

Description Sets or queries the CV control mode (local control, external voltage control, external resistance control). This setting is applied only after the unit is reset.

Syntax SYSTEM:CONFigure:VOLTage:CONTRol { 0 | 1 | 2 | 3 }

Query Syntax SYSTEM:CONFigure:VOLTage:CONTRol?

Parameter/Return	<NR1>	Description
	0	Local (Panel) control
	1	External voltage control
	2	External resistance control; 10kΩ = Vo max, 0kΩ = Vo min.
	3	External resistance control; 10kΩ = Vo min, 0kΩ = Vo max.

SYSTEM:CONFigure:MSLave
 →
 →

Description Sets or queries the unit operation mode. This setting is only applied after the unit has been reset.

Parameter	0	Output off at power up
	OFF	Output off at power up
	1	Output on at power up
	ON	Output on at power up
Return Parameter	0	Output off at power up
	1	Output on at power up

Set →

← Query

SYSTem:COMMunicate:ENABle

Description Enables/Disables LAN, GPIB or USB remote interfaces as well as remote services (Sockets, Web Server).

Syntax SYSTem:COMMunicate:ENABle <mode>,<interface>

Query Syntax SYSTem:COMMunicate:ENABle? <interface>

Parameter	<mode>	
	OFF	Turns the selected mode off.
	0	Turns the selected mode off.
	ON	Turns the selected mode on.
	1	Turns the selected mode on.
	<interface>	
	GPIB	Select GPIB
	USB	Select USB
	LAN	Select LAN
	SOCKETs	Select Sockets
	WEB	Select the web server
Return Parameter	0	The selected mode is off.
	1	The selected mode is on.

Example SYST:COMM:ENAB 1,USB
Turns the USB interface on.

Query Example SYST:COMM:ENAB? USB
1
Queries the USB state, returns 1 (USB is on).

SYSTem:COMMunicate:GPIB[:SELF]:ADDR Set →
 ess →Query

Description	Sets or queries the GPIB address.
Syntax	SYSTem:COMMunicate:GPIB[:SELF]:ADDRess <NR1>
Query Syntax	SYSTem:COMMunicate:GPIB[:SELF]:ADDRess?
Parameter/Return	<NR1> 0~30
Example	SYST:COMM:GPIB:SELF:ADDR 15 Sets the GPIB address to 15.

SYSTem:COMMunicate:LAN:IPADdress Set →
→Query

Description	Sets or queries LAN IP address.
Syntax	SYSTem:COMMunicate:LAN:IPADdress <string>
Query Syntax	SYSTem:COMMunicate:LAN:IPADdress?
Parameter/Return	<string> LAN IP address in string format ("address") Applicable ASCII characters: 20H to 7EH
Example	SYST:COMM:LAN:IPAD "172.16.5.111" Sets the IP address to 172.16.5.111.

SYSTem:COMMunicate:LAN:GATEway Set →
→Query

Description	Sets or queries the Gateway address.
Syntax	SYSTem:COMMunicate:LAN:GATEway <string>
Query Syntax	SYSTem:COMMunicate:LAN:GATEway?
Parameter/Return	<string> Gateway address in string format ("address") Applicable ASCII characters: 20H to 7EH
Example	SYST:COMM:LAN:GATE "172.16.0.254" Sets the LAN gateway to 172.16.0.254.

SYSTem:COMMunicate:LAN:SMASk Set →
→Query

Description	Sets or queries the LAN subnet mask.
-------------	--------------------------------------

Syntax	SYSTem:COMMunicate:LAN:SMASK <string>
Query Syntax	SYSTem:COMMunicate:LAN:SMASK?
Parameter/Return	<string> Subnet mask in string format ("mask") Applicable ASCII characters: 20H to 7EH
Example	SYST:COMM:LAN:SMASK "255.255.0.0" Sets the LAN mask to 255.255.0.0.

SYSTem:COMMunicate:LAN:MAC → **Query**

Description	Returns the unit MAC address as a string. The MAC address cannot be changed.
Query Syntax	SYSTem:COMMunicate:LAN:MAC?
Return parameter	<string> Returns the MAC address in the following format "FF-FF-FF-FF-FF-FF"
Example	SYST:COMM:LAN:MAC? 02-80-AD-20-31-B1 Returns the MAC address.

→ **Set**

SYSTem:COMMunicate:LAN:DHCP → **Query**

Description	Turns DHCP on/off. Queries the DHCP status.
Syntax	SYSTem:COMMunicate:LAN:DHCP {OFF ON 0 1}
Query Syntax	SYSTem:COMMunicate:LAN:DHCP?
Parameter	0 DHCP off OFF DHCP off 1 DHCP on ON DHCP on
Return parameter	0 <boolean>DHCP off 1 <boolean>DHCP on

→ **Set**

SYSTem:COMMunicate:LAN:DNS → **Query**

Description	Sets or queries the DNS address.
Syntax	SYSTem:COMMunicate:LAN:DNS <string>
Query Syntax	SYSTem:COMMunicate:LAN:DNS?

Parameter/Return	<string>	DNS in string format (“mask”) Applicable ASCII characters: 20H to 7EH
Example	SYST:COMM:LAN:DNS “172.16.1.252”	Sets the DNS to 172.16.1.252.

SYSTem:COMMunicate:USB:FRONt:STATe → **Query**

Description	Queries the front panel USB-A port state.	
Query Syntax	SYSTem:COMMunicate:USB:FRONt:STATe?	
Return parameter	0	<NR1>Absent
	1	<NR1>Mass Storage

SYSTem:COMMunicate:USB:REAR:STATe → **Query**

Description	Queries the rear panel USB-B port state.	
Query Syntax	SYSTem:COMMunicate:USB:REAR:STATe?	
Return parameter	0	<NR1>Absent
	1	<NR1>USB-CDC
	2	<NR1>GPIB-USB (GUG-001)

SYSTem:ERRor → **Query**

Description	Queries the error queue. The last error message is returned. A maximum of 32 errors are stored in the error queue.	
Query Syntax	SYSTem:ERRor?	
Paramter/Return	<NR1>,<string>	Returns an error code followed by an error message as a string. The string is returned as “string”.
Example	SYSTem:ERRor? -100, “Command error”	

Set →

SYSTem:KLOCK → **Query**

Description	Enables or disables the front panel key lock.	
-------------	-----------------------------------------------	--

Syntax	SYSTem:KLOCK { OFF ON 0 1 }	
Query Syntax	SYSTem:KLOCK?	
Parameter	0	Panel keys unlocked
	OFF	Panel keys unlocked
	1	Panel keys locked
	ON	Panel keys locked
Return parameter	0	<boolean>Panel keys unlocked
	1	<Boolean>Panel keys locked

SYSTem:VERSIon → Query

Description	Returns the version of the SCPI specifications that the unit complies with.
Query Syntax	SYSTem:VERSIon?
Return	<1999.0> Always returns the SCPI version: 1999.0.

IEEE 488.2 Common Commands

*CLS	60
*ESE	60
*ESR	60
*IDN	60
*OPC	61
*RST	61
*SRE	61
*STB	62
*TRG	62
*TST	62
*WAI	62

***CLS**

Set →

Description The *CLS command clears the Standard Event Status, Operation Status and Questionable Status registers. The corresponding Enable registers in each of the above registers are not cleared.

If a <NL> newline code immediately precedes a *CLS command, the Error Que and the MAV bit in the Status Byte Register is also cleared.

Syntax *CLS

***ESE**

Set →

→ Query

Description Sets or queries the Standard Event Status Enable register.

Syntax *ESE <NR1>

Query Syntax *ESE?

Parameter <NR1> 0~255

Return parameter <NR1> Returns the bit sum of the Standard Event Status Enable register.

***ESR**

→ Query

Description Queries the Standard Event Status (Event) register. The Event Status register is cleared after it is read.

Query Syntax *ESR?

Return parameter <NR1> Returns the bit sum of the Standard Event Status (Event) register and clears the register.

***IDN**

→ Query

Description Queries the manufacturer, model name, serial number, and firmware version of the PSW.

Query Syntax *IDN?

Return parameter <string> Returns the instrument identification as a string in the following format:
 GW-INSTEK,PSW-3036,TW123456,01.00.20110101
 Manufacturer: GW-INSTEK
 Model number : PSW-3036
 Serial number : TW123456
 Firmware version : 01.00.20110101

Set →

***OPC**

→ Query

Description The *OPC command sets the OPC bit (bit0) of the Standard Event Status Register when all current commands have been processed.
 The *OPC? Query returns 1 when all the outstanding commands have completed.

Syntax *OPC

Query Syntax *OPC?

Return parameter 1 Returns 1 when all the outstanding commands have completed.

***RST**

Set →

Description Performs a device reset. Configures the unit to a known configuration (default settings). This known configuration is independent of the usage history.

Syntax *RST

Set →

***SRE**

→ Query

Description Sets or queries the Service Request Enable register. The Service Request Enable register determines which registers of the Status Byte register are able to generate service requests.

Syntax *SRE <NR1>

Query Syntax *SRE?

Parameter	<NR1>	0~255
Return parameter	<NR1>	Returns the bit sum of the Service Request Enable register.

***STB**

→ Query

Description Queries the bit sum of the Status Byte register with MSS (Master summary Status) bit replacing the RQS bit (bit 6).

Query Syntax *STB?

Return parameter <NR1> Returns the bit sum of the Status Byte register with the MSS bit (bit 6).

***TRG**

Set →

Description The *TRG command is able to generate a “get” (Group Execute Trigger). If the PSW cannot accept a trigger at the time of the command, an error message is generated (-211, “Trigger ignored”).

Syntax *TRG

***TST**

→ Query

Description Executes a self test.

Query Syntax *TST?

Return parameter 0 Returns “0” if there are no errors.
 <NR1> Returns an error code <NR1> if there is an error.

***WAI**

Set →

Description Prevents any other commands or queries from being executed until all outstanding commands have completed.

Syntax *WAI

Status Register Overview

To program the PSW power supply effectively, the Status registers need to be understood. This chapter explains in detail how the Status registers are used and how to configure them.

Introduction to the Status Registers.....	63
The Status Registers	64
Questionable Status Register Group.....	65
Operation Status Register Group.....	67
Standard Event Status Register Group.....	70
Status Byte Register & Service Request Enable Register ..	72

Introduction to the Status Registers

Overview

The status registers are used to determine the status of the power supply. The status registers maintain the status of the protection conditions, operation conditions and instrument errors.

The PSW Series have a number of register groups:

- Questionable Status Register Group
- Standard Event Status Register Group
- Operation Status Register Group
- Status Byte Register
- Service Request Enable Register
- Service Request Generation
- Error Queue
- Output Buffer

The next page shows the structure of the Status registers.

The Status Registers

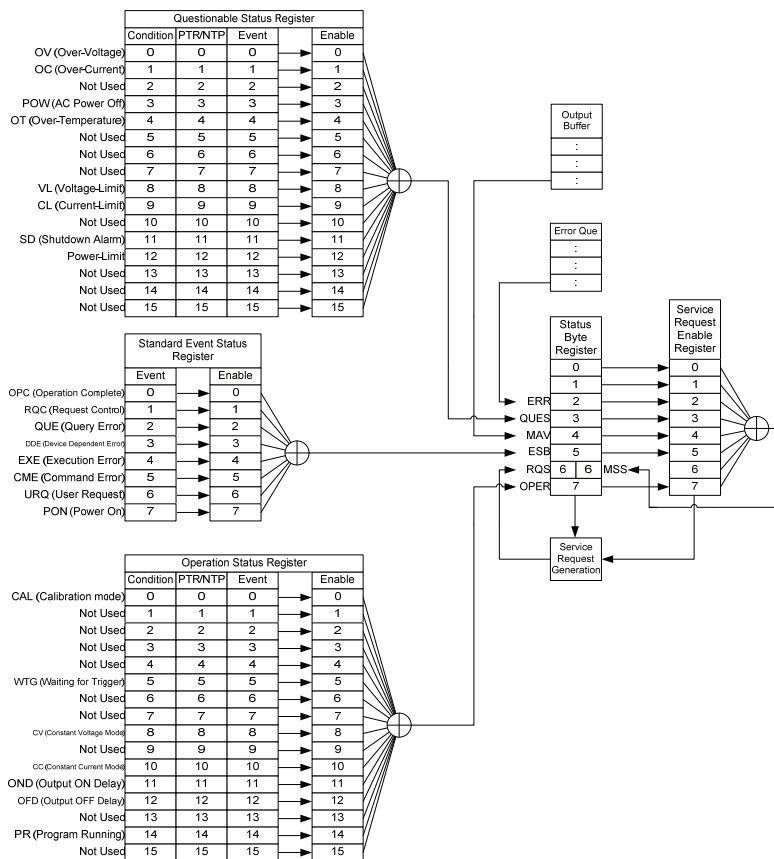

Questionable Status Register Group

Overview

The Questionable Status Register Group indicates if any protection modes or limits have been tripped.

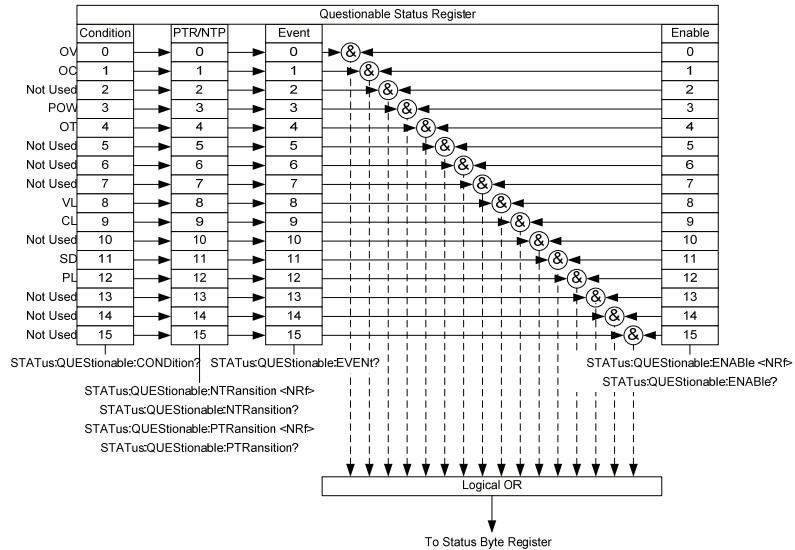

Bit Summary

Event	Bit #	Bit Weight
OV (Over-Voltage)	0	1
Over voltage protection has been tripped		
OC (Over-Current)	1	2
Over current protection has been tripped		
POW (AC Power Off)	3	8
AC power switch is off		

OT (Over Temperature)	4	16
Over temperature protection has been tripped		
VL (Voltage Limit)	8	256
Voltage limit has been reached		
CL (Current Limit)	9	512
Current limit has been reached		
SD (Shutdown Alarm)	11	2048
PL (Power-Limit)	12	4096

Condition Register The Questionable Status Condition Register indicates the status of the power supply. If a bit is set in the Condition register, it indicates that the event is true. Reading the condition register does not change the state of the condition register.

PTR/NTR Filters The PTR/NTR (Positive/Negative transition) register determines the type of transition conditions that will set the corresponding bit in the Event Registers. Use the Positive transition filter to view events that change from false to positive, and use the negative transition filter to view events that change from positive to negative.

Positive Transition	0→1
Negative Transition	1→0

Event Register The PTR/NTR Register will dictate the type of transition conditions will set the corresponding bits in the Event Register. If the Event Register is read, it will be cleared to 0.

Enable Register The Enable register determines which Events in the Event Register will be used to set the QUES bit in the Status Byte Register.

Operation Status Register Group

Overview

The Operation Status Register Group indicates the operating status of the power supply.

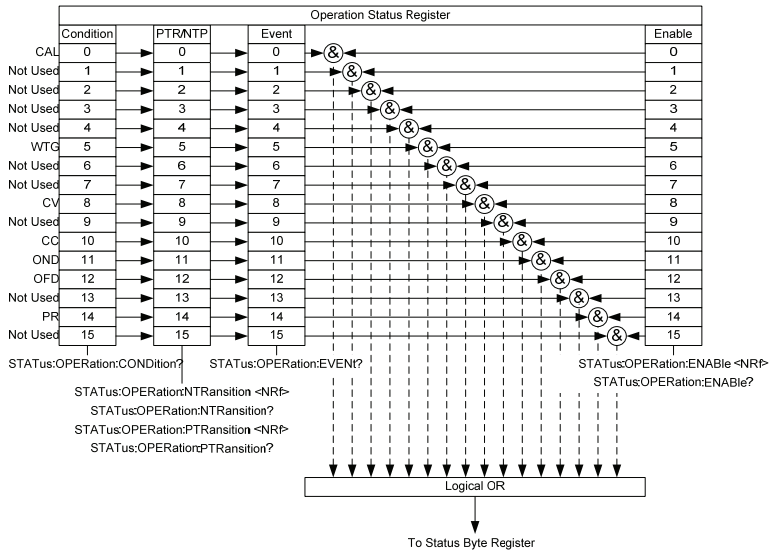

Bit Summary

Event	Bit #	Bit Weight
CAL (Calibration mode)	0	1
Indicates if the PSW is in calibration mode.		
WTG (Waiting for trigger)	5	32
Indicates if the PSW is waiting for a trigger.		
CV (Constant voltage mode)	8	256
Indicates if the PSW is in CV mode.		

	CC (Constant current mode)	10	1024
	Indicates if the PSW is in CC mode.		
	OND (Output ON Delay)	11	2048
	Indicates if Output ON delay time is active		
	OFD (Output OFF Delay)	12	4096
	Indicates if Output OFF delay time is active		
	PR (Program Running)	13	8192
	Indicates if a Test is running		
Condition Register	The Operation Status Condition Register indicates the operating status of the power supply. If a bit is set in the Condition register, it indicates that the event is true. Reading the condition register does not change the state of the condition register.		
PTR/NTR Filters	The PTR/NTR (Positive/Negative transition) register determines the type of transition conditions that will set the corresponding bit in the Event Registers. Use the Positive transition filter to view events that change from false to positive, and use the negative transition filter to view events that change from positive to negative.		
	Positive Transition	0→1	
	Negative Transition	1→0	
Event Register	The PTR/NTR Register will dictate the type of transition conditions will set the corresponding bits in the Event Register. If the Event Register is read, it will be cleared to 0.		

Enable Register

The Enable register determines which registered Events in the Event Register will be used to set the OPER bit in the Status Byte Register.

Standard Event Status Register Group

Overview

The Standard Event Status Register Group indicates if any errors have occurred. The bits of the Event register are set by the error event queue.

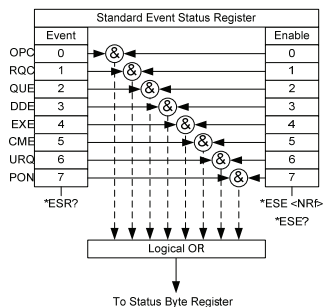

Bit Summary

Event	Bit #	Bit Weight
OPC (Operation complete)	0	1
The OCP bit is set when all selected pending operations are complete. This bit is set in response to the *OPC command.		
RQC (Request control)	1	2
QUE (Query Error)	2	4
The Query Error bit is set in response to an error reading the Output Queue. This can be caused by trying to read the Output Queue when there is no data present.		
DDE (Device Dependent Error)	3	8
Device specific error.		

EXE (Execution Error)	4	16
-----------------------	---	----

The EXE bit indicates an execution error due to one of the following: illegal command parameter, parameter out of range, invalid parameter, the command didn't execute due to an overriding operation condition.

CME (Command Error)	5	32
---------------------	---	----

The CME bit is set when a syntax error has occurred. The CME bit can also be set when a <GET> command is received within a program message.

URQ (User Request)	6	64
--------------------	---	----

PON (Power On)	7	128
----------------	---	-----

Indicates the power is turned on.

Event Register	Any bits set in the event register indicate that an error has occurred. Reading the Event register will reset the register to 0.
----------------	----------------------------------------------------------------------------------------------------------------------------------

Enable Register	The Enable register determines which Events in the Event Register will be used to set the ESB bit in the Status Byte Register.
-----------------	--------------------------------------------------------------------------------------------------------------------------------

Status Byte Register & Service Request Enable Register

Overview

The Status Byte register consolidates the status events of all the status registers. The Status Byte register can be read with the *STB? query or a serial poll and can be cleared with the *CLS command. When a serial poll is executed the RQS bit generates a service request. A serial poll will not clear any of the Status byte registers.

An *STB query will ready the status byte register with the MSS bit, not the RQS bit.

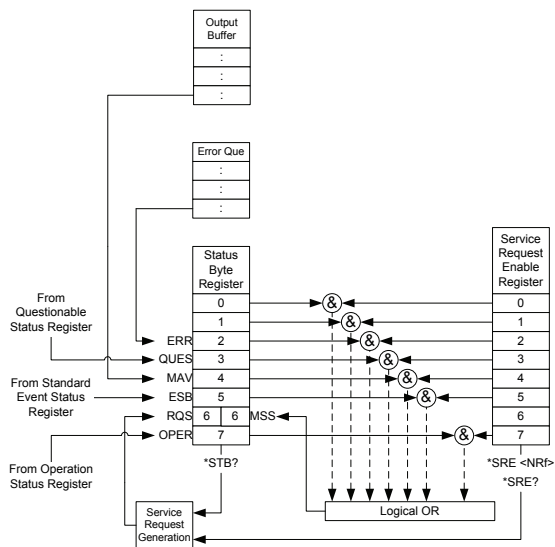

Bit Summary

Event	Bit #	Bit Weight
ERR (Error Event/Queue)	2	4

If data is present in the Error queue, the ERR bit will be set.

QUES (Questionable Status Register)	3	8
The summary bit for the Questionable Status Register group.		
MAV (Message Available) This is set when there is data in the Output Queue waiting to be read.	4	16
(ESB) Event Summary Bit. The ESB is the summary bit for the Standard Event Status Register group.	5	32
MSS/RQS Bit	6	64
The MSS Bit is the summary of the Status Byte Register and Service Request register (bits 1-5, 7). This will be set to 1. The MSS Bit is not cleared with a Serial Poll.		
The RQS Bit is set when the instrument receives a Service Request. A serial poll is then performed and the contents of the Status Byte Register is sent with the RQS bit set as 1. The RQS bit is cleared after the serial poll, ready for the next Service Request.		
OPER (Operation Status Register)	7	128
OPER bit is the summary bit for the Operation Status Register Group.		

Status Byte Register	Any bits set in the Status byte register acts as a summary register for all the three other status registers and indicates if there is a service request, an error in the Error Queue or data in the Output Queue. Reading the Status Byte register will reset the register to 0.
Service Request Enable Register	The Service Request Enable Register controls which bits in the Status Byte Register are able to generate service requests.

Error List

Command Errors.....	75
Execution Errors	79
Device Specific Errors	81
Query Errors	82

Command Errors

Overview

An <error/event number> in the range [-199 , -100] indicates that an IEEE 488.2 syntax error has been detected by the instrument's parser. The occurrence of any error in this class shall cause the command error bit (bit 5) in the event status register (IEEE 488.2, section 11.5.1) to be set. One of the following events has occurred:

- An IEEE 488.2 syntax error has been detected by the parser. That is, a controller-to-device message was received which is in violation of the IEEE 488.2 standard. Possible violations include a data element which violates the device listening formats or whose type is unacceptable to the device.
- An unrecognized header was received. Unrecognized headers include incorrect device-specific headers and incorrect or unimplemented IEEE 488.2 common commands.

Events that generate command errors shall not generate execution errors, device-specific errors, or query errors; see the other error definitions in this chapter.

Error Code	Description
-100 Command Error	This is the generic syntax error for devices that cannot detect more specific errors. This code indicates only that a Command Error as defined in IEEE 488.2,11.5.1.1.4 has occurred.
-102 Syntax error	An unrecognized command or data type was encountered; for example, a string was received when the device does not accept strings.
-103 Invalid separator	The parser was expecting a separator and encountered an illegal character; for example, the semicolon was omitted after a program message unit, MEAS:VOLT:DC?:MEASCURR:DC?
-104 Data type error	The parser recognized a data element different than one allowed; for example, numeric or string data was expected but block data was encountered.
-108 Parameter not allowed	More parameters were received than expected for the header; for example, the KLOCK command only accepts one parameter, so receiving SYSTem:KLOCK 1,0 is not allowed.
-109 Missing parameter	Fewer parameters were received than required for the header; for example, the KLOCK command requires one parameter, so receiving KLOCK is not allowed.
-111 Header separator error	A character which is not a legal header separator was encountered while parsing the header; for example, no white space followed the header, thus APPL5,1 is an error.

-112 Program mnemonic too long	The header contains more than twelve characters (see IEEE 488.2, 7.6.1.4.1).
-113 Undefined header	The header is syntactically correct, but it is undefined for this specific device; for example, *XYZ is not defined for any device.
-114 Header suffix out of range	The value of a numeric suffix attached to a program mnemonic, see Syntax and Style section 6.2.5.2, makes the header invalid.
-115 Unexpected number of parameters	The number of parameters received does not correspond to the number of parameters expected. This is typically due to an inconsistency with the number of instruments in the selected group.
-120 Numeric data error	This error, as well as errors -121 through -129, are generated when parsing a data element which appears to be numeric, including the nondecimal numeric types. This particular error message should be used if the device cannot detect a more specific error.
-121 Invalid character in number	An invalid character for the data type being parsed was encountered; for example, an alpha in a decimal numeric or a "9" in octal data.
-128 Numeric data not allowed	A legal numeric data element was received, but the device does not accept one in this position for the header.
-131 Invalid suffix	The suffix does not follow the syntax described in IEEE 488.2, 7.7.3.2, or the suffix is inappropriate for this device.

-141 Invalid character data	Either the character data element contains an invalid character or the particular element received is not valid for the header.
-148 Character data not allowed	A legal character data element was encountered where prohibited by the device.
-151 Invalid string data	A string data element was expected, but was invalid for some reason (see IEEE 488.2, 7.7.5.2); for example, an END message was received before the terminal quote character.
-158 String data not allowed	A string data element was encountered but was not allowed by the device at this point in parsing.
-160 Block data error	This error, as well as errors -161 through -169, are generated when parsing a block data element. This particular error message should be used if the device cannot detect a more specific error.
-161 Invalid block data	A block data element was expected, but was invalid for some reason (see IEEE 488.2, 7.7.6.2); for example, an END message was received before the length was satisfied.
-168 Block data not allowed	A legal block data element was encountered but was not allowed by the device at this point in parsing.
-178 Expression data not allowed	A legal expression data was encountered but was not allowed by the device at this point in parsing.

Execution Errors

Overview An <error/event number> in the range [-299 , -200] indicates that an error has been detected by the instrument's execution control block. The occurrence of any error in this class shall cause the execution error bit (bit 4) in the event status register (IEEE 488.2, section 11.5.1) to be set. One of the following events has occurred:

- A <PROGRAM DATA> element following a header was evaluated by the device as outside of its legal input range or is otherwise inconsistent with the device's capabilities.
- A valid program message could not be properly executed due to some device condition.

Execution errors shall be reported by the device after rounding and expression evaluation operations have taken place. Rounding a numeric data element, for example, shall not be reported as an execution error. Events that generate execution errors shall not generate Command Errors, device-specific errors, or Query Errors; see the other error definitions in this section.

Error Code	Description
-200 Execution error	This is the generic syntax error for devices that cannot detect more specific errors. This code indicates only that an Execution Error as defined in IEEE 488.2, 11.5.1.1.5 has occurred.

-201 Invalid while in local	Indicates that a command is not executable while the device is in local due to a hard local control (see IEEE 488.2, 5.6.1.5); for example, a device with a rotary switch receives a message which would change the switches state, but the device is in local so the message can not be executed.
-203 Command protected	Indicates that a legal password-protected program command or query could not be executed because the command was disabled.
-211 Trigger ignored	Indicates that a GET, *TRG, or triggering signal was received and recognized by the device but was ignored because of device timing considerations; for example, the device was not ready to respond. Note: a DT0 device always ignores GET and treats *TRG as a Command Error.
-213 Init ignored	Indicates that a request for a measurement initiation was ignored as another measurement was already in progress.
-220 Parameter error	Indicates that a program data element related error occurred. This error message should be used when the device cannot detect the more specific errors described for errors -221 through -229.
-221 Settings conflict	Indicates that a legal program data element was parsed but could not be executed due to the current device state (see IEEE 488.2, 6.4.5.3 and 11.5.1.1.5.).

-222 Data out of range	Indicates that a legal program data element was parsed but could not be executed because the interpreted value was outside the legal range as defined by the device (see IEEE 488.2, 11.5.1.1.5.).
-224 Illegal parameter value	Used where exact value, from a list of possibles, was expected.

Device Specific Errors

Overview	<p>An <error/event number> in the range [-399 , -300] or [1 , 32767] indicates that the instrument has detected an error which is not a command error, a query error, or an execution error; some device operations did not properly complete, possibly due to an abnormal hardware or firmware condition. These codes are also used for self-test response errors. The occurrence of any error in this class should cause the device-specific error bit (bit 3) in the event status register (IEEE 488.2, section 11.5.1) to be set. The meaning of positive error codes is device-dependent and may be enumerated or bit mapped; the <error message>string for positive error codes is not defined by SCPI and available to the device designer.</p>
----------	------------------------------------------------------------------------------------------------------------------------------------------------------------------------------------------------------------------------------------------------------------------------------------------------------------------------------------------------------------------------------------------------------------------------------------------------------------------------------------------------------------------------------------------------------------------------------------------------------------------------------------------------------------------------------------------------------------------------------------------------------------------------

Note that the string is not optional; if the designer does not wish to implement a string for a particular error, the null string should be sent (for example, 42,""). The occurrence of any error in this class should cause the device-specific error bit (bit 3) in the event status register (IEEE 488.2, section 11.5.1) to be set. Events that generate device-specific errors shall not generate command errors, execution errors,

or query errors; see the other error definitions in this section.

Error Code	Description
-310 System error	Indicates that some error, termed “system error” by the device, has occurred. This code is device-dependent.
-320 Storage fault	Indicates that the firmware detected a fault when using data storage. This error is not an indication of physical damage or failure of any mass storage element.

Query Errors

Overview

An <error/event number> in the range [-499 , -400] indicates that the output queue control of the instrument has detected a problem with the message exchange protocol described in IEEE 488.2, chapter 6. The occurrence of any error in this class shall cause the query error bit (bit 2) in the event status register (IEEE 488.2, section 11.5.1) to be set. These errors correspond to message exchange protocol errors described in IEEE 488.2, section 6.5. One of the following is true:

- An attempt is being made to read data from the output queue when no output is either present or pending;
- Data in the output queue has been lost.

Events that generate query errors shall not generate command errors, execution errors, or device-specific errors; see the other error definitions in this section.

Error Code	Description
-400 Query error	This is the generic query error for devices that cannot detect more specific errors. This code indicates only that a Query Error as defined in IEEE 488.2, 11.5.1.1.7 and 6.3 has occurred.

APPENDIX

PSW Default Settings

The following default settings are the factory configuration settings for the power supply (Function settings/Test settings).

Normal Function		
Settings	Setting	Default Setting
Output ON delay time	F-01	0.00s
Output OFF delay time	F-02	0.00s
V-I mode slew rate select	F-03	0 = CV high speed priority
Rising voltage slew rate	F-04	60V/s (PSW 30-XX) 160V/s (PSW 80-XX)
Falling voltage slew rate	F-05	60V/s (PSW 30-XX) 160V/s (PSW 80-XX)
Rising current slew rate	F-06	72.00A/s (PSW 30-36) 144.0A/s (PSW 30-72) 216.0A/s (PSW 30-108) 27.00A/s (PSW 80-13.5) 54.00A/s (PSW 80-27) 81.00A/s (PSW 80-40.5)
Falling current slew rate	F-07	72.00A/s (PSW 30-36) 144.0A/s (PSW 30-72) 216.0A/s (PSW 30-108) 27.00A/s (PSW 80-13.5) 54.00A/s (PSW 80-27) 81.00A/s (PSW 80-40.5)
Internal resistance setting	F-08	0.000Ω
Bleeder circuit control	F-09	1 = ON
Buzzer ON/OFF control	F-10	0 = ON
USB/GPIB setting		
Front panel USB State	F-20	0 = Absent

Rear panel USB State	F-21	0 = Absent
Rear Panel USB Mode	F-22	2 = USB CDC
GPIO address	F-23	8

LAN setting

MAC Address-1	F-30	0x00~0xFF
MAC Address-2	F-31	0x00~0xFF
MAC Address-3	F-32	0x00~0xFF
MAC Address-4	F-33	0x00~0xFF
MAC Address-5	F-34	0x00~0xFF
MAC Address-6	F-35	0x00~0xFF
LAN	F-36	1 = Enable
DHCP	F-37	1 = Enable
IP Address-1	F-39	0
IP Address-2	F-40	0
IP Address-3	F-41	0
IP Address-4	F-42	0
Subnet Mask-1	F-43	0
Subnet Mask-2	F-44	0
Subnet Mask-3	F-45	0
Subnet Mask-4	F-46	0
Gateway-1	F-47	0
Gateway-2	F-48	0
Gateway-3	F-49	0
Gateway-4	F-50	0
DNS address -1	F-51	0
DNS address -2	F-52	0
DNS address-3	F-53	0
DNS address-4	F-54	0
Sockets active	F-57	1 = Enable
Web Server active	F-59	1 = Enable
Web password active	F-60	1 = Enable
Web setting password	F-61	0000

Power On Configuration

CV Control	F-90	0= Panel control (local)
CC Control	F-91	0= Panel control (local)
Power-ON Output	F-92	0 = OFF at startup
Master/Slave	F-93	0 = Master/Local
External Out Logic	F-94	0= High ON
Power Switch trip	F-95	1 = Disable

Calibration

Calibration	F-00	0000
-------------	------	------

Test Setting		
Test Run	T-01	1
Test Save	T-02	1
Test Recall	T-03	1
Test Remove	T-04	1

Error Messages & Messages

The following error messages or messages may appear on the PSW screen during operation.

Error Messages	Description
Err 001	USB Mass Storage is not present
Err 002	No (such)file in USB mass storage
Err 003	Empty memory location

Messages	Description
MSG 001	External control of output. Output off (F-94=0, High=on)
MSG 002	External control of output. Output off (F-94=1, Low=on)
MSG 003	No connection. (F-93=1 or F-93=2)

LCD Display Format

Use the following table to read the LCD display messages.

0	1	2	3	4	5	6	7	8	9	A	B	C	D
0	1	2	3	4	5	6	7	8	9	A	b	C	d
E	F	G	H	I	J	K	L	M	N	O	P	Q	R
E	F	G	H	I	J	K	L	M	N	O	P	Q	R
S	T	U	V	W	X	Y	Z	()	+	-	,		
S	T	U	V	W	X	Y	Z	()	+	-	,		

INDEX

Caution symbol.....	4	Messages	86
Cleaning the instrument	6	Model differences	9
Configuration		Power on/off	
normal function settings		safety instruction	5
operation	17	Rear panel diagram	14
table	18	Remote control	21
Default settings	84	Command list.....	29
Display format	86	Command syntax	26
Disposal instructions	6	Error list	75
EN61010		Ethernet configuration.....	24
measurement category	5	GPIB configuration.....	23
pollution degree.....	6	Status registers	62
Environment		USB configuration	22
safety instruction	6	Remote control function check..	25
Error messages	86	Service operation	
Front panel diagram.....	11	about disassembly	5
Ground		UK power cord	7
symbol	4	Warning symbol.....	4
LCD conversion	86	Web server function check.....	25
List of features.....	10		